

Industrial & Retail Range CATALOGUE





IDONSA ■

Why Settle for Anything Less?

Are you managing a shopfloor operating 24/7? If so, then you will know that your factory chairs are not only used as a seat, but also as loungers, trolleys and logistic tools. Does this result in you continuously fixing or replacing your shopfloor chairs?

The IDONSA is a no-nonsense, robust, hygienic and comfortable chair that is designed for heavy 24/7 usage. By including our unique NUGEN footring that remains at the correct height, the Idonsa can be tailor-made for your specific environment. Simply tell us the workstation height and we will manufacture accordingly! Furthermore, we can colour-code the chairs to ensure they remain in their designated areas.

The IDONSA range is ideal for the highly demanding industrial, food processing, laboratory, retail, medical, surgical, logistical and distribution centre environments.

Features:

- Robust design for 24/7 usage. Fixed backrest thereby reducing the number of moving components.
- Easy to clean vinyl upholstery including the underside of the seat.
- Easy-Grab® Bumper Edge fitted to the backrest to protect the backrest and machinery against damage (optional).
- Automotive grade moulded foam for greater comfort and longevity.
- Gas seat height adjustment.
- Base options include, Black Nylon 5-star, Polished Aluminium 5-star or Black Round Nylon. The 5-star bases are fitted with either 60mm castors or glides. Note: Glides are recommended for polished or slippery surfaces.
- Various seat heights, viz. 440-570mm (no footring), 580-680mm (with nugen footring), 650-750mm (with nugen footring), 680-810mm (with nugen footring), 750-880mm (with nugen footring).
- Karo's unique rigid NUGEN footring with durable chrome outer-ring and nylon support structure.
- 2 Year Warranty

IDONSA SPECIFICATIONS



Idonsa

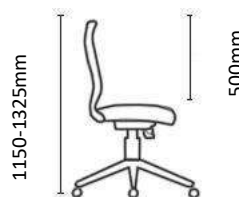

Chair Weight: 20kg



490mm

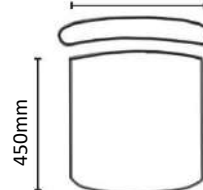

640mm

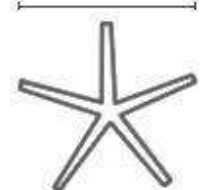



DELTA ■

Delta Task Chair

The DELTA Task chair has a classic functional design! High performance automotive grade, moulded foam is used for the seat upholstery. Multiple seat height options are available. The draughting chair also has the uniquely stable Karo Footring. The DELTA Task chair has an ergonomically contoured back which is easily adjusted so that the user can find a comfortable position from which to work.

Features:

- Upholstered backrest with integral lumbar support.
- Ergonomic, height adjustable backrest.
- Back tilt and height adjustment mechanism.
- Upholstered seat with automotive grade high-density moulded foam.
- One-touch height adjustment.
- Optional Adjustable armrests with 2 degrees of freedom and polyurethane pad.
- 640mm diameter black nylon 5 star base with 60mm castors for improved maneuverability.
- Various seat heights, viz. 440-570mm (no footring), 680-810mm (with Karo Draughting Footring), 750-880m (with Karo Draughting Footring).
- 5 Year Warranty

DELTA SPECIFICATIONS

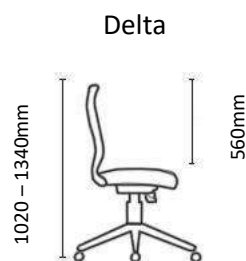

Chair Weight: 9-15kg

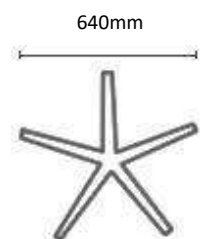
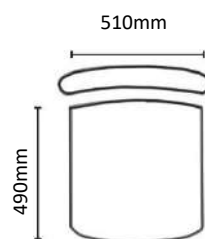



DELTA PU

Smart Ergonomic Workspace Solutions



Delta PU Operator Range

The Delta PU Operator Range of Laboratory and Industrial chairs has a classic functional design. Manufactured from easy to maintain black Integral Skin Polyurethane foam with a sculptured geometric detail. The ergonomically contoured back is easily adjusted to suit any user. The Delta draughting chair option is fitted with Karo's unique Nugen rigid footring.

Features:

- Black Integral Skin Polyurethane foam backrest and seat
- Ideal for rigorous industrial, laboratory, retail, medical and surgical environments.
- Internal steel support structure (not wood!) for superior strength
- Height adjustable seat and backrest
- Optional Karo's unique rigid footring with a durable chrome outer-ring and nylon support structure.
- Base options include, Black Nylon 5-star, Polished Aluminium 5-star or Black Round Nylon. The 5-star bases are fitted with either 60mm castors or glides.
- Various seat heights, viz. 440-570mm (no footring), 580-680mm (with footring), 650-750mm (with footring), 680-810mm (with footring), 750-880mm (with footring).
- 2 Year Warranty.

DELTA PU SPECIFICATIONS

Chair Weight: 12kg

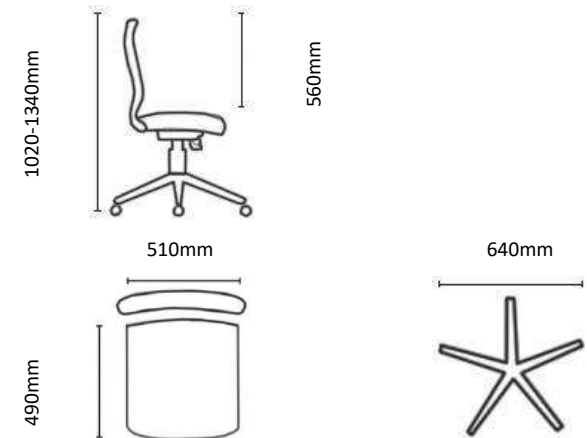

ROUND PU



A Cleaners Dream...

When space is a premium and corporate identity at the forefront. The Round PU Stool is perfect for cashiers, laboratory, medical, workshop, commercial, hairdresser or factory environments. With its black Integral Skin Polyurethane (PU) foam it is not only comfortable but an absolute delight to clean, especially for laboratory and medical users. No matter the workstation height, the round PU Stool is a “fits all” stool.

Features:

- Integral Skin Polyurethane foam.
- Easy to clean.
- Simple height adjustment
- Selection of bases, viz. Black Nylon 5-star, Polished Aluminium 5-star or Black Round Nylon. The 5-star bases are fitted with either 60mm castors or glides.
- Karo’s unique rigid NUGEN footring with durable chrome outer-ring and nylon support structure.
- Various seat heights, viz. 520-700mm (no footring), 580-680mm (with nugen footring), 650-750mm (with nugen footring), 680-810mm (with nugen footring), 750-880mm (with nugen footring).
- 2 Year Warranty.

ROUND PU SPECIFICATIONS



Chair Weight: 9kg



400mm

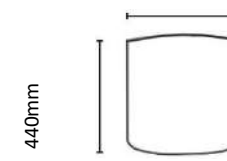

640mm

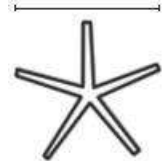

440mm

SIT/STAND PU



Industrial Beauty

As the name implies, the Sit-Stand Polyurethane (PU) operator stool is ideal for those people who just need a little bit of support before moving on to their next task, whether this be in the office, laboratory, production line or workshop. With its black integral skin polyurethane seat, the Sit-Stand is very easy to clean and ideal in all environments where cleanliness is imperative, or grease and oil are just part of the job! Whatever the height of your workstation, the Sit-Stand can be customised to the correct height. With a built-in clutch handle and weighing in at a mere 6kg, the Sit-Stand easily accompanies you on your next task.

Features:

- Black Integral Skin Polyurethane foam seat with clutch-handle for easy movement.
- Easy to clean.
- Selection of bases, viz. Black Nylon 5-star, Polished Aluminium 5-star or Black Round Nylon. The 5-star bases are fitted with either 60mm castors or glides.
- Karo's unique rigid **NUGEN** footring with durable chrome outer-ring and nylon support structure.
- Various seat heights, viz. 520-700mm (no footring), 580-680mm (with Nugen footring), 650-750mm (with Nugen footring), 680-810mm (with Nugen footring), 750-880mm (with Nugen footring).
- 2 Year Warranty.

SIT/STAND PU SPECIFICATIONS

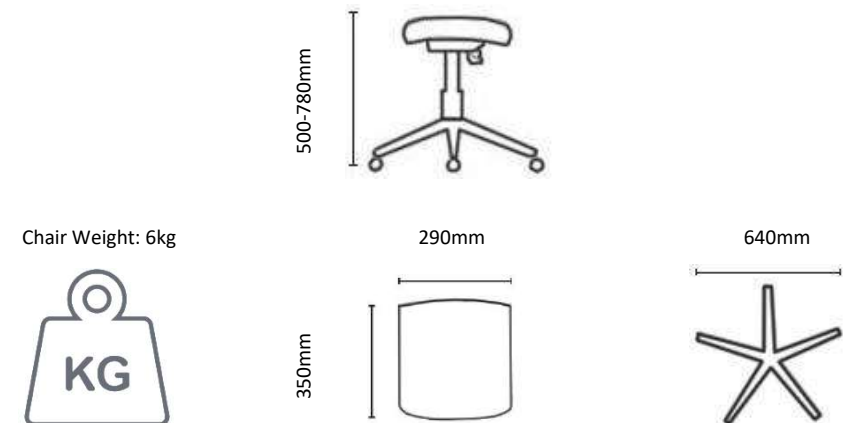

PILL TOP



Active Space Saver...

For those on the move or when sitting for long periods is not an option. The Pill-Top stool is ideal for “check ins” at the office or a ‘perch’ for your sit-stand desk or workbench. Ideal for rigorous industrial, laboratory, retail, hairdresser, dental, medical and surgical environments where space can be at a premium. Light and compact, the Pill-Top stool can be easily stored away or packed together with your toolbox for when you are on the move!

Features:

- Unique 360-degree height activation lever.
- Upholstered automotive grade moulded foam seat that can be upholstered in a variety of fabrics or washable vinyl.
- Karo’s unique rigid NUGEN footring with durable chrome outer-ring and nylon support structure
- Base options include, Black Nylon 5-star, Polished Aluminium 5-star or Black Round Nylon.
The 5-star bases are fitted with either 60mm castors or glides.
- Various seat heights, viz. 490-620mm (no footring), 580-680mm (with nugen footring), 650-750mm (with nugen footring), 680-810mm (with nugen footring), 750-880mm (with nugen footring).
- 2 Year Warranty.

PILL TOP SPECIFICATIONS

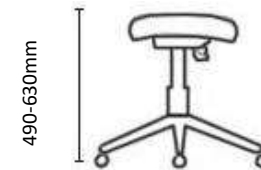

Chair Weight: 6kg



370mm

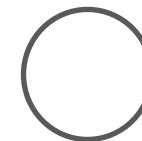

680mm



BUCKET RANGE



Simply Industrial

The BUCKET range is specially designed for factory environments: packaging operations, production lines, general warehousing and factory operations where workstation heights vary. The BUCKET SEAT range is the ideal choice where function, strength, OH&S and hygiene are prerequisites. The many configuration options allow you to select the ideal chair for the task.

Features:

- Polypropylene seat and backrest manufactured to stadium seating specifications.
- For use in rigorous industrial/production environments with machine operators working consecutive shifts on a 24/7 basis.
- Completely washable.
- Locally manufactured to specifications.
- 2 Year Warranty.

BUCKET OPERATOR



Five Star Base Option

- Base options include, Black Nylon 5-star, Polished Aluminium 5-star or Black Round Nylon. The 5-star bases are fitted with either 60mm castors or glides.
- Various seat heights, viz. 440-570mm (no footring), 580-680mm (with footring), 650-750m (with footring), 680-810m (with footring), 750-880m (with footring).
- Karo's unique rigid footing with a durable chrome outer-ring and nylon support structure.



BUCKET OPERATOR SPECIFICATIONS



Chair Weight: 10kg

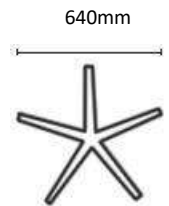
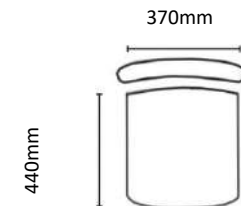

BUCKET 4-LEGGED



4-Legged Option

- Powder-coated, extra-strong square steel tube frame.
- Various colour options available.
- Various seat heights, viz. 480mm, 580mm, 720mm, 820mm and 920mm.



BUCKET 4-LEGGED SPECIFICATIONS

Chair Weight: 8kg



370mm

440mm

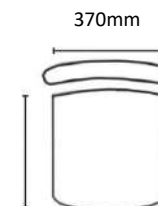

640mm

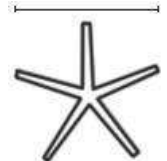



BONNETT GLOBAL SOURCING

Bev Bonnett:
bev@bonnettgs.co.za
m: +27 74 145 8002

Don Kriel:
don@bonnettgs.co.za
m: +27 82 780 6538

www.bonnettgs.co.za

2020 Catalogue